

Performance criteria

Door width acc. to EN	≤ 1,400 mm	3-6
Dimensions (incl. mounting plate)	Length in mm	409
	Depth in mm	51,5
	Height in mm	65
Supply voltage		24V DC
Mounting types	DIN L = DIN R hinge side = opposite hinge side Standard installation = frame installation	■ ■ ■
Latching speed (continuously adjustable)		■
Closing speed (continuously adjustable)		■
Door opening angle		up to 180°
Free swing function can be activated		1-180°
Protection class		IP 20
Tested to EN standards		EN 1154
		EN 1155
Suitable for fire and smoke control doors		F
Certified according to EU regulations		CE

- Yes
- No
- Optional

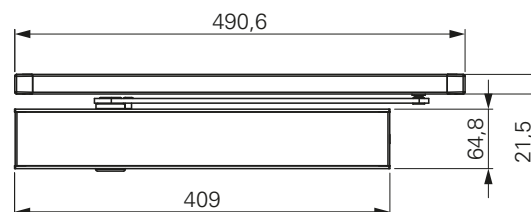
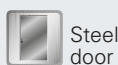
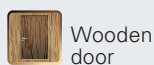

Dimensions: ECO FTS III

ECO FTS III ■ ... in special applications

With the latest ECO FTS III and the slide rail ECO GS-HF, ECO Schulte is launching a hold-open device for use in objects with accessibility requirements. The main areas of application for the free swing door closer therefore include old people's homes, kindergartens, schools, hospitals and other properties where doors need to be opened and closed with as little effort as possible.

The ECO FTS III can be used in all mounting types, one version for both DIN L and DIN R, hinge and opposite hinge side, as well as for standard and frame installation. In combination with the ECO SR III, the ECO FTS III can also be used on double-leaf doors. The connecting cable to the ECO FTS III can be surface-mounted or invisibly mounted (concealed cable connection).

The free swing function is activated from the first degree of opening angle, so that the door only needs to be opened once to the desired angle. After that, the door can be moved freely without any annoying resistance (door opening torques below 25 Nm - **DIN EN 18040**).

The hold-open device is triggered by the on-site fire alarm system or an additional manual switch or by switching off the 24 V supply voltage (power failure).

With its identical appearance to the ECO Newton generation of door closers, it fits perfectly into the ECO door closer world. As such, all requirements for FS/RS or functional doors can be met in the property with the same visually and functionally high-quality claim.



Standards



Benefits / USPs



Continuously adjustable closing force EN 3–6.
High-quality, thermostable valves for continuously adjustable CS and LS.



Can be combined with slide rail GS-HF in mounting type DL= DR, BS =BG, NM = KM.
Can be combined with ECO SR III and ECO SR BG III



Uniform ECO Newton design, therefore visually perfectly combinable with the ECO Newton door closer series.
Vandalism-proof U-Click cover made of stainless steel, matt brushed.



Simple installation with concealed mounting plate and prefabricated plug-in connections.



Optional stainless steel full cover for closer body and slide rail



Practical combined packaging for set FTS III with GS-HF and all accessories.

Benefits / USPs

Technical parameters

- Free swing door closer ECO FTS III with continuous SK **EN 3–6**, tested and certified according to **EN 1154** and **EN 1155**, for use on FS/RS doors, especially for the construction of accessible buildings as per **DIN EN 18040**.
- One ECO FTS III for all mounting types:
DIN L = DIN R
Hinge side = Opposite hinge side
Standard installation = frame installation

In combination with ECO SR III / SR BG III, can also be used for 2-leaf FS/RS doors.
- Prefabricated assembly groups enable simple, fast and fault-free installation.
- Choice of mounting type with concealed (on-site device required) or surface-mounted cable duct.
- Height-adjustable slide rail ECO GS-HF, adjusting range ± 3 mm.
- Slide rail flush with FTS III body, thereby providing a visually elegant design.

- Opening angle: 0–180°
- Free swing function: from 1-180°
- Max. return angle: below 5°
- Door thicknesses up to 100 mm possible:
X dimension: 60–95 mm
Y dimension: up to 57 mm
- SK – closing force, continuous
- SG – closing speed, continuous
- ES – latching speed, continuous

Technical data

ECO FTS III (EN 3–6)

Door closer with electromechanical free swing function

- **Controlled via:** external fire alarm systems
- **Hold-open point:** 1–180° (free swing function)
- **Connection:** 24 V DC ±15%
- **Power consumption:** 2.7 W (114 mA)
- **Installation:** DIN L = DIN R, hinge side = opposite hinge side, standard installation = frame installation
- **Area of application:** -15 to +45°, max. relative humidity: 95%
- **Protection class:** IP 20
- **Slide rails:** ECO GS-HF, ECO SR (BG) III

Suitable for the following door types



Wooden door



Steel door



Profile door

Suitable for the following building types



Health



Public



Educational



Office

Tender text

ECO set FTS III GS-HF

Slide rail door closer with free swing function with adjustable closing force **EN 3–6**

For use on single-leaf FS/RS doors up to 1,400 mm certified according to **EN 1154** and **EN 1155**

TS aluminium design body with integrated, invisible mounting plate, stainless steel cover with vandalism-proof clip technology, closing speed and latching speed continuously adjustable.

Opening angle max. 180°, free swing function 1–180°.

Temperature range from -15 to + 45°, max. 95% relative humidity

With free swing lever and height-adjustable slide rail ECO GS-HF

Mounting optionally with concealed or surface-mounted cable duct

One model for all mounting types:

DL=DR, hinge side=opposite hinge side, standard installation=frame installation

Surface:

() Silver RAL 9006 (cover stainless steel, matt)

() White RAL 9016

() RAL free choice ...

() Matt stainless steel

Article numbers



Free swing door closer set with lever arm and slide rail GS-HF	Colour	Art. no.
Set ECO FTS III GS-HF (3-6)	Silver RAL 9006	5030064525
Set ECO FTS III GS-HF (3-6)	White RAL 9016	5030064771
Set ECO FTS III GS-HF (3-6)	Black RAL 9005	On request
Set ECO FTS III GS-HF (3-6)	Stainless steel	On request

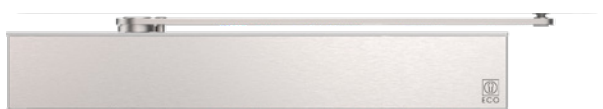

Free swing door closer with lever arm, without slide rail (for combination with ECO SR (BG) III)	Colour	Art. no.
ECO FTS III (3-6)	Silver RAL 9006	5030064770
ECO FTS III (3-6)	White RAL 9016	5030064769
ECO FTS III (3-6)	Black RAL 9005	On request
ECO FTS III (3-6)	Stainless steel	On request

Installation

Hinge side

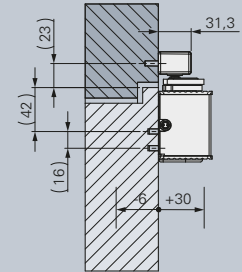
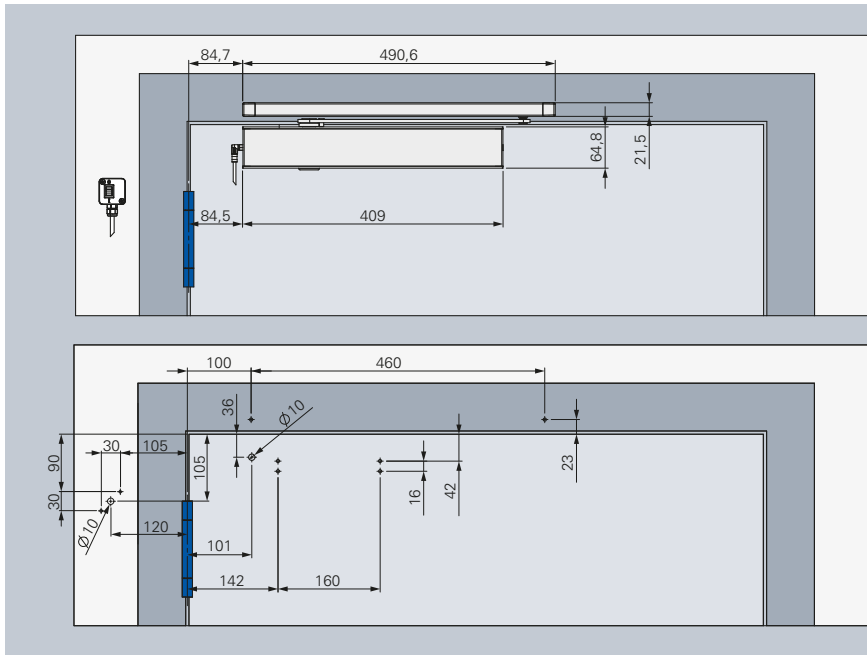

Standard installation, hinge side, DIN L – ECO **FTS III**

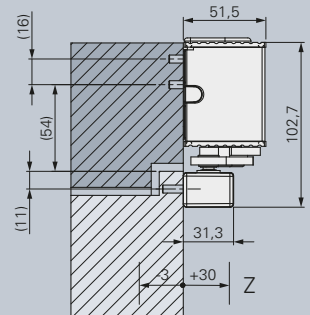
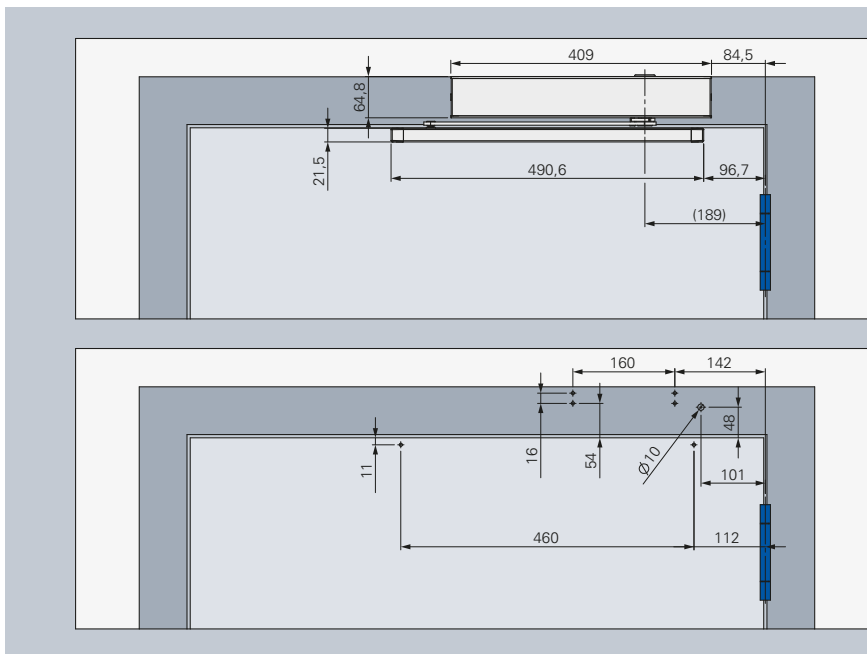

Frame installation, hinge side, DIN R – ECO **FTS III**

Installation

Opposite hinge side

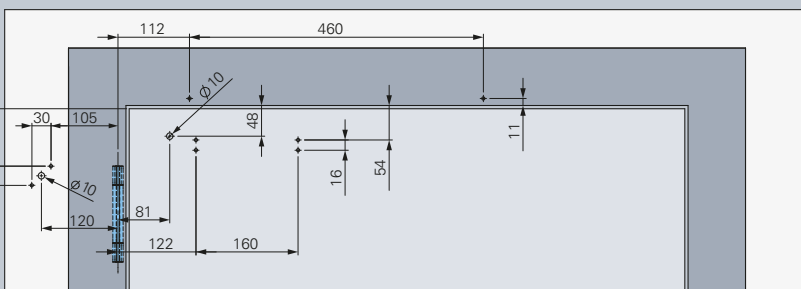
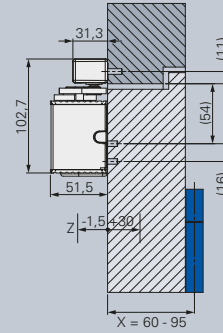
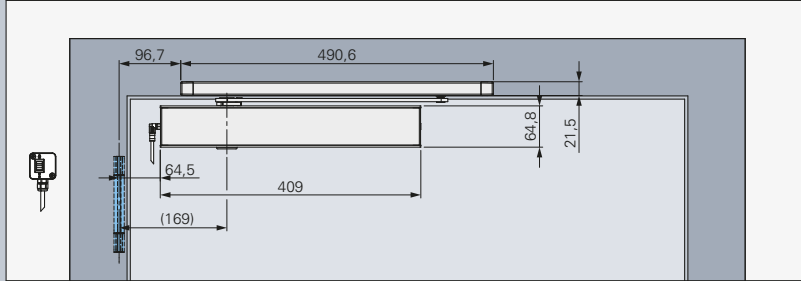

Standard installation, opposite hinge side, DIN R – ECO FTS III

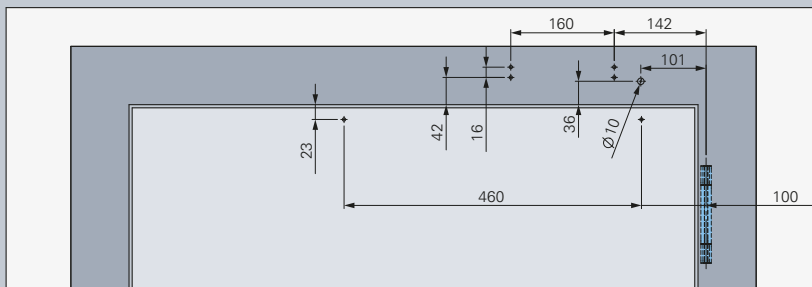
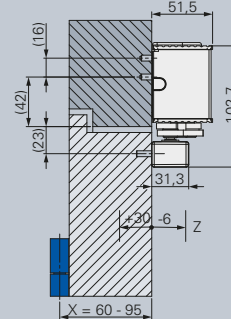
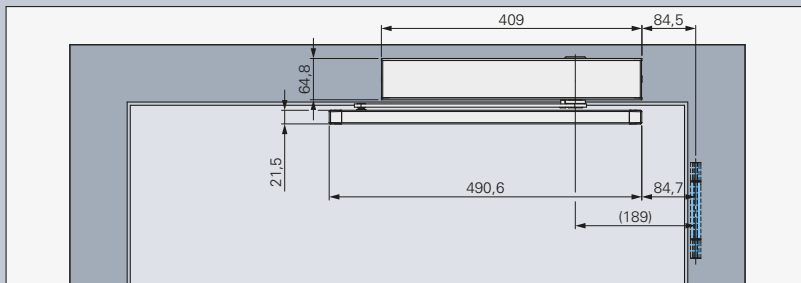

Frame installation, opposite hinge side, DIN L – ECO FTS III

ECO Schulte GmbH & Co. KG

Iserlohner Landstraße 89

D-58706 Menden

Telephone +49 2373 9276 - 0

Telefax +49 2373 9276 - 40

info@eco-schulte.de

www.eco-schulte.de

Our compendium represents a compilation of all products from our range of services. These are subject to different delivery classes. Special variants included are often manufactured to customer specifications and sometimes require longer delivery times and minimum purchase quantities. Further advise can be given by your contact person.

■ SYSTEM TECHNOLOGY FOR THE DOOR

