

Montage

plafond & wand

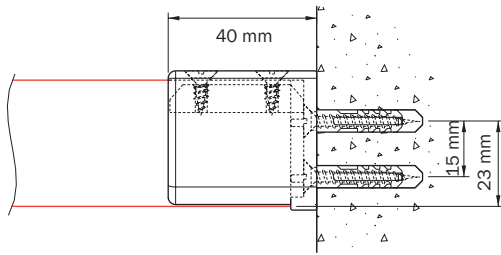

wandmontage 4100 met dagsteun 4149

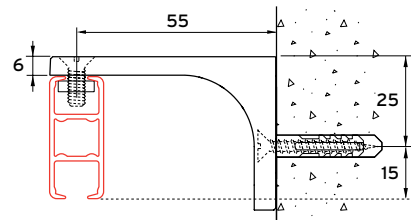

wandmontage met muurbeugel 4140

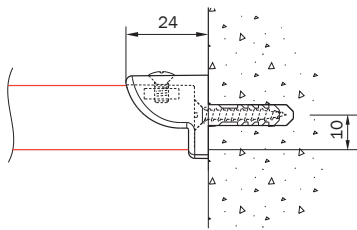

wandmontage 4200 met dagsteun 4249

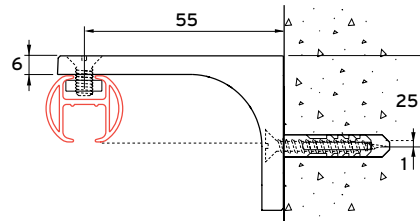

montage 4200 met muurbeugel 5140

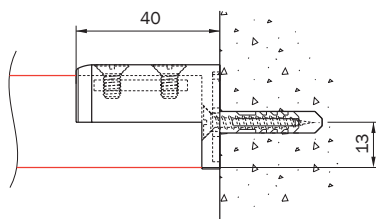

wandmontage 5100 met dagsteun 5149

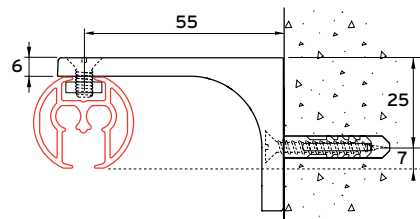

montage 5100 met muurbeugel 5140

Pendels

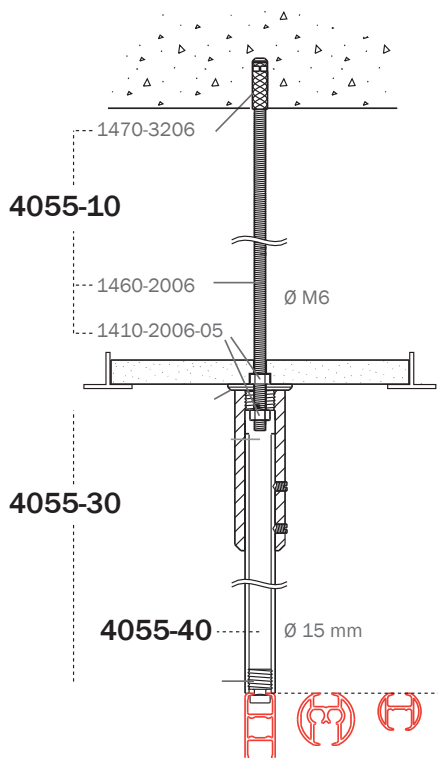

- plafondmontage 4100, 5100 of 4200
aan pendel 4055-40 met montageset 4055-30,
pendel aan draadeindset 4055-10.

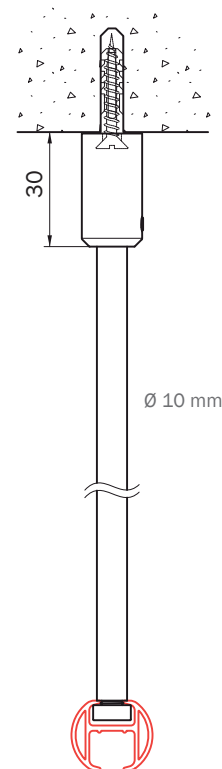

plafondmontage met 4255

Toepassingsvoorbeelden

standaard doucheraail situaties en pendelposities

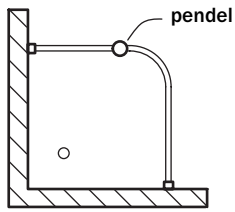

L-vormig (douche)

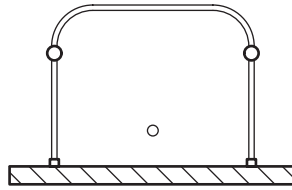

U-vormig (douche)

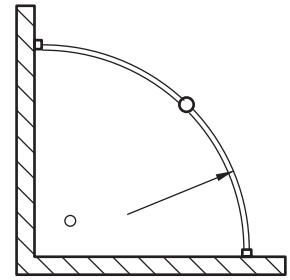

speciaal (bijvoorbeeld hoekbaden)

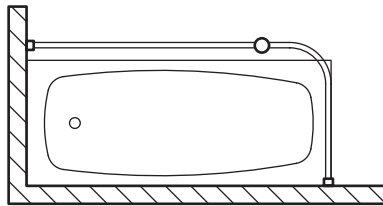

L-vormig (bad)

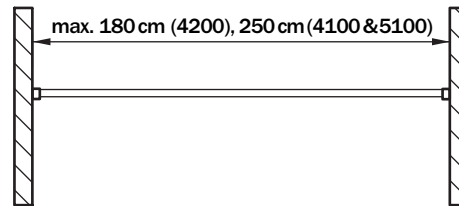

rechte rail

haakse verbindingen in 4100 en 5100

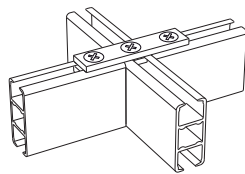

railverbinder 4130

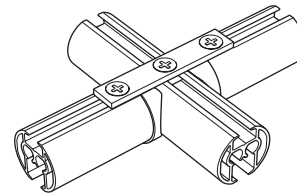

railverbinder 5130

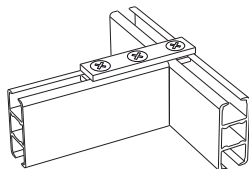

railverbinder 4130
als haakse verbinder

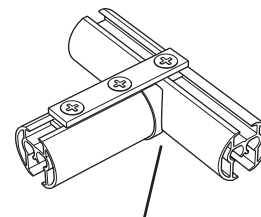

railverbinder 5130
als haakse verbinder

holle einddeksel 5153-20

G-Norm 4100, 4200 & 5100

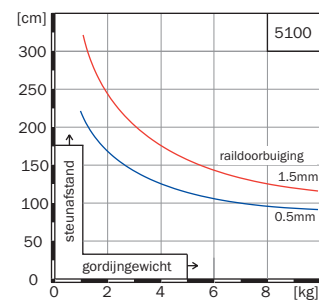
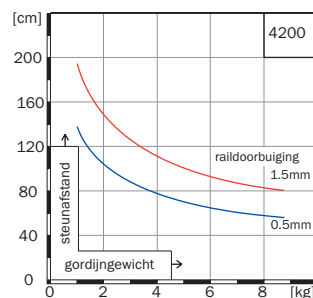
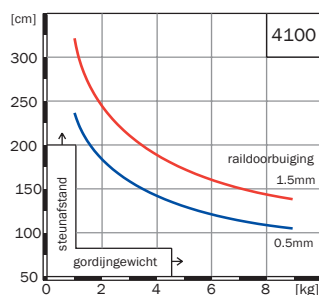

Onderdelen

Gordijntransport



4002
eindstop zonder oog



4003-W
eindveer



4007
glijder draaibaar



4007-60
glijder draaibaar met RVS haak

Plafondmontage

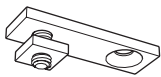

4135 (t.b.v. 4100)
5135 (t.b.v. 4200 & 5100)
plafondsteun



4254
plafondklos 3 cm



4255
pendel (4200)

Pendel, bestaat uit:

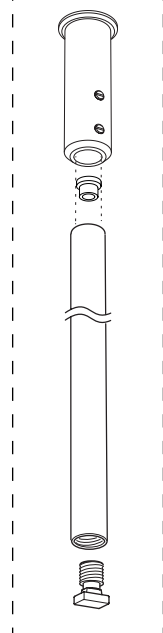

4055-30
diverse montagesets
inclusief plafondklos
ook sets voor
NEN1010

4055-40
pendelstang,
eenzijdig getapt
50, 100 of 150cm

Wandmontage

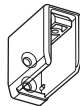

4149
dagsteun, ook
t.b.v. NEN 1010
(4100)



4249
dagsteun, ook
t.b.v. NEN 1010
(4200)



5149
dagsteun, ook
t.b.v. NEN 1010
(5100)

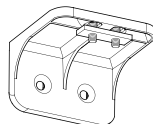

4140 (t.b.v. 4100)
5140 (t.b.v. 4200, 5100)
kunststof muurbeugel
5,5 cm, ook t.b.v.
NEN 1010

Accessoires

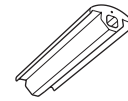

4145
flexibele
anti-stof strip

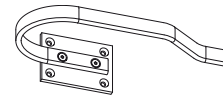

4170
gordijnhouder
met achterplaat

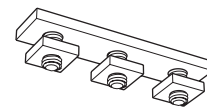

4130 (4100)
5130 (5100)
railverbinder voor
haakse verbinding

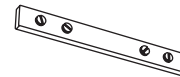

5152
railverbinder
(4200 & 5100)



5153-20
holle einddeksel
i.c.m. 5130
(5100)

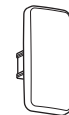

4153
einddeksel
(4100)



4253
einddeksel
(4200)



5153
einddeksel
(5100)

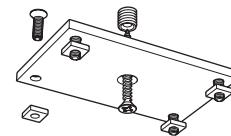

4116-10 (4100)
5116-10 (4200, 5100)
dubbeldrager voor 4055

4116-20 (4100)
5116-20 (4200, 5100)
dubbeldrager zonder gat

4116-30 (4100)
5116-30 (4200, 5100)
dubbeldrager voor 4064

NEN-1010

NEN-1010 betekent geïsoleerde railbevestiging. Voor meer informatie hierover graag contact opnemen met Goelst NL te Ede.