



Movexx **T1000**
ONDERDELEN & OPTIES
2019

Specificaties

Technische gegevens

Frame	Staal, gepoedercoat
Aandrijving	24V DC, 600W, 100 toeren/min
Gewicht	300 kg (incl. accu)
Gew. aanhanger	3500 kg
Accu	Ingebouwd
Snelheid	4,7 km/h
Aandrijfwielen	Massief rubber Ø 250x80 mm
Werkhoogte	750-1269 mm (variabel)
Geluidsniveau	68,5 dB
Gebruikers temp.	-10 °C / 40 °C
Bescherm klasse	Machine IP44

© 2019 Movexx International B.V. The images shown are used for illustration purposes only and may differ from the products indicated. No rights can therefore be derived from it. Printing errors are subjected to change.

Trekkracht (in kg)

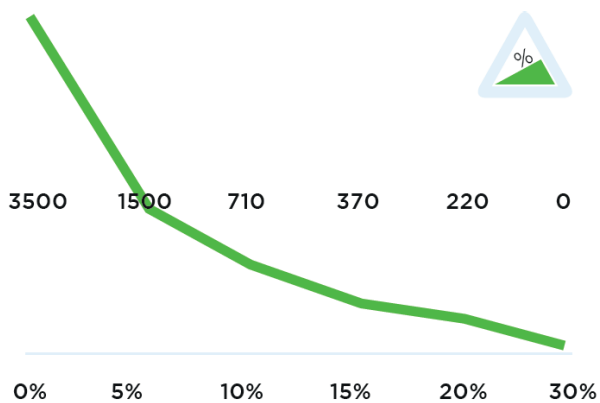

Gemeten met een trolley met 2 zwenkwielen en 2 bokwheels. Wioldiameter: 160mm

Dimensies

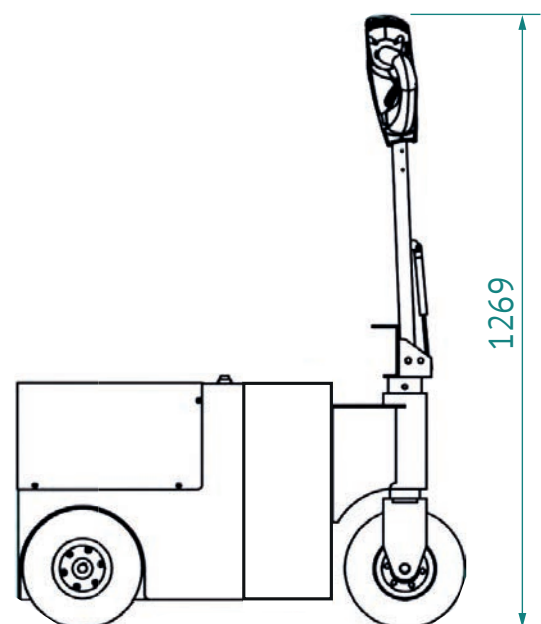
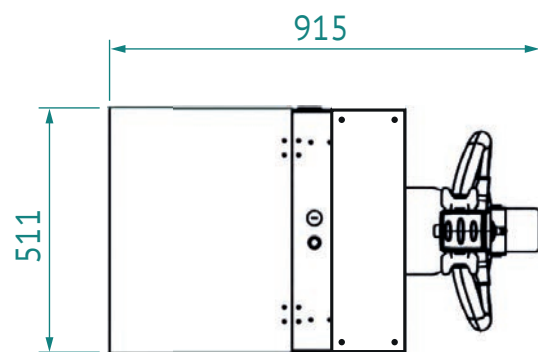

Standaard onderdelen



Motor 600W / 100rpm
(6911413X) met rem
Artikel Nr M2098



Accuconditiometer 3-leds
Artikel Nr M0123



Batterij AGM-VRLA
12V / 80Ah
Artikel Nr M2102



Acculader (intern) voor
AGM Batterij, 24V / 10A
+ externe conditiometer
Artikel Nr M2134



Aandrijf wiel, massief rubber
zwart Ø 250 x 80mm
Artikel Nr M0248



Stuurwiel, massief rubber
zwart Ø 250 x 80mm
Item number M6019

Standaard onderdelen



Verstelbare disselkop
Artikel Nr M2503



Omkeerschakelaar ROOD
Artikel Nr M0121-BBUT



2 programmeerbare
snelheden

Opties



UPGRADE: aandrijfwielen
Massief rubber, nonmarking
Grijs 3x Ø 250 x 80mm
Artikel Nr OPT0358



Claxon 90dB voor
stalen disselkop steun
Artikel Nr OPT0057

Opties



Claxon 103dB
Artikel Nr OPT0059



Noodstop
Artikel Nr OPT0063



Flitslamp voor
stalen disselkop steun
Item number OPT0065



Flitslamp op mast
Artikel Nr OPT0119

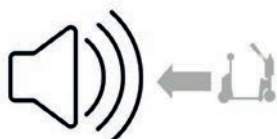

Geluids signaal
(bij vooruit rijden)
Artikel Nr OPT0253



Geluids signaal
(bij achteruit rijden)
Artikel Nr OPT0254

Opties



Urenteller
Artikel Nr OPT0056



Antistatische strip
Artikel Nr OPT0058



Veiligheids bumper
Artikel Nr OPT0079



Vorbereiding
electrische haak
Artikel Nr OPT0143

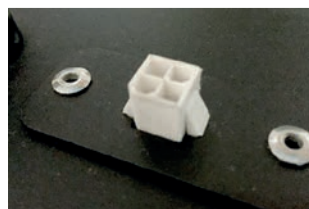

Diagnose-stekker
aansluiting
Artikel Nr OPT0270



Contactslot
(ongelijke sleutel)
Artikel Nr OPT0145

Opties



Contactslot
(gelijke sleutel 701)
Artikel Nr OPT0146



Aan/uit draaischakelaar
Artikel Nr OPT0016



Parkeer vloersticker
Ø 60 cm
Artikel Nr OPT0245



Klantspecifieke
programmering
Artikel Nr OPT0170



Programmer Italsea
Artikel Nr D0003



Maximaal gewicht
Artikel Nr OPT0172

Opties

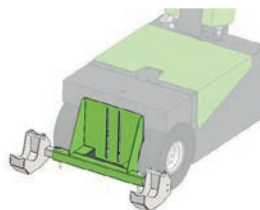

U-frame voor Afval-
container 1000 l. / 1100 l.
Artikel Nr OPT0088

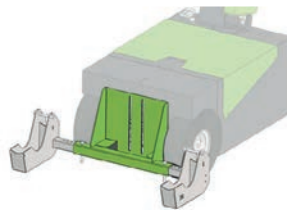

Adapter voor
winkelwagens (90°)
Artikel Nr OPT0324



Adapter voor
Airportrolley (90°)
Artikel Nr OPT0327



Uitschakeling
Artikel Nr OPT0153

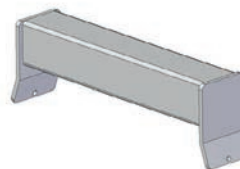

Lasbeugel
(profiel 50x50mm)
Artikel Nr OPT0032



Schroefbare trekkoker
(profiel 50x50mm)
Artikel Nr OPT0033

Opties



Bevestiging voor
winkelwagen
Artikel Nr OPT0040



Spoedorder kosten
Artikel Nr SPOED



Frontbediening
Artikel Nr OPT0380



Voorbereiding Laadstation
Artikel Nr OPT0352

Batterijen en opladers



Acculader (intern) voor
AGM Batterij, 24V / 10A
+ externe conditiemeter
Artikel Nr M2134



UPGRADE:
Batterij Lithium
25,6V / 120Ah (LiFePO4)
Artikel Nr OPT0459

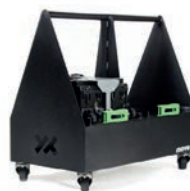

AGM Acculader
roll-on/off (inkl. 1 Batterij
blok 24V / 80Ah)
Artikel Nr OPT0071



Lithium Ladegerät
roll-on/off (inkl. 1 Batterie-
satz 25,6V / 120Ah)
Artikel Nr OPT0460

Batterijen en opladers



Batterij AGM-VRLA
12V / 80Ah
Artikel Nr M2102

Adapters



Basisdeel haak 90°
Artikel Nr H7030

Adapters



Basisdeel haak 90°
(met extra veer)
Artikel Nr H7040

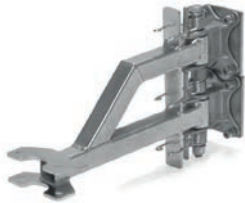

Basisdeel HD-haak 90°
(verlaagd)
Artikel Nr H7070

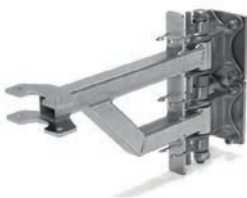

Basisdeel HD-haak 90°
(verhoogd)
Artikel Nr H7080



Basisdeel haak 90°
(manuelle bediening)
Artikel Nr H7090

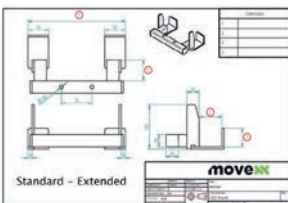

Klantspecifieke haak
*Afmetingen op detail-
tekening aangeven*
Artikel Nr HA5000

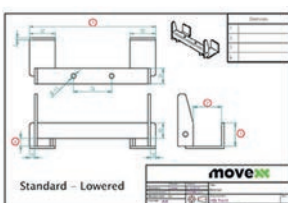

Klantspecifieke haak
(verlaagd)
*Afmetingen op detail-
tekening aangeven*
Artikel Nr HB5000

Adapters

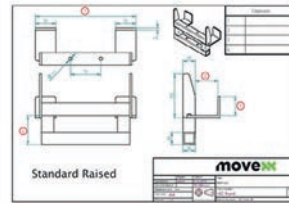

Klantspecifieke haak
(verhoogd)
*Afmetingen op detail-
tekening aangeven*
Artikel Nr HC5000

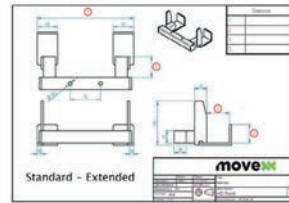

Klantspecifieke haak
(verlengd)
*Afmetingen op detail-
tekening aangeven*
Artikel Nr HD5000

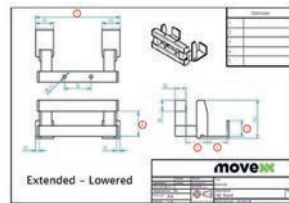

Klantspecifieke haak
(verlengd, verlaagd)
*Afmetingen op detail-
tekening aangeven*
Artikel Nr HE5000

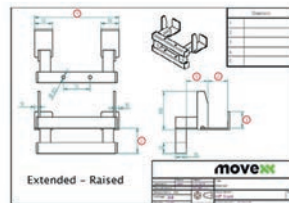

Klantspecifieke haak
(verlengd, verhoogd)
*Afmetingen op detail-
tekening aangeven*
Artikel Nr HF5000



Kogelkoppeling Ø 50mm
(incl. adapter)
Artikel Nr H0068



Haak voor LKE Plattform-
wagen (Type X)
Artikel Nr H0076

Adapters



Haak K-Hartwall dolly
(DOS1617/1636, 90°)
Artikel Nr H0083



Electrische hefmodule
voor haak (heavy duty)
Artikel Nr OPT0271



Electrische borgmodule
voor haak
Artikel Nr OPT0129

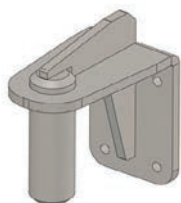

Pen voor trekstang Ø35
Artikel Nr H0144



Aanhangerkoppeling met
frame, pen Ø25
Artikel Nr H0062



Aanhangerkoppeling met
frame, pen Ø32
Artikel Nr H0146

Adapters



Trekhaak voor Movexx
E-frame
(geschikt voor OPT0067)
Artikel Nr H0070



Pen voor trekstang Ø15
Artikel Nr H0071



Pen voor trekstang Ø10
Artikel Nr H0072



Klaphaak
voor bloemenkar
Artikel Nr OPT0099



Klaphaak Ø16
Artikel Nr H0128-D16



Klaphaak Ø20
Artikel Nr H0128-D20

Adapters



Klaphaak Ø25
Artikel Nr H0128-D25



Klaphaak Ø27
Artikel Nr H0128-D27



Klaphaak Ø32
Artikel Nr H0128-D32



Klaphaak Ø35
Artikel Nr H0128-D35

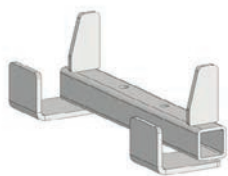

HA270.43.40.0.0
Haak voor 40 mm profiel
(K-Hartwall pallet trolley;
DOS1870)
Artikel Nr H0003

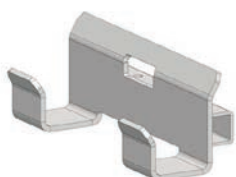

HA245.55.45.15.0
Haak voor 50 mm profiel
Artikel Nr H0004

Adapters

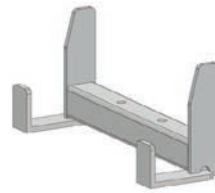

HA250.43.35.0.0
Haak voor 40 mm profiel
Artikel Nr H0051

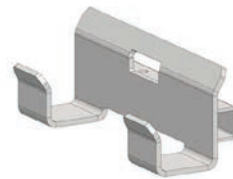

HB245.43.30.5.0
Haak voor 40 mm profiel
Artikel Nr H0054

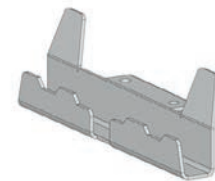

HA250.23.27.0.0
Haak voor 20 mm profiel
Artikel Nr H0067

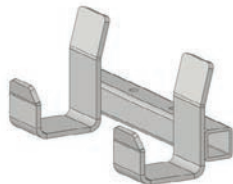

HB245.60.45.30.0
FEIL kunststof rolcontainer
Artikel Nr H0092



HC250.28.25.0.0
Haak voor 25 mm profiel
Artikel Nr H0094

Meest voorkomende onderdelen



Batterij AGM-VRLA
12V / 80Ah
Artikel Nr M2102



Acculader (intern) voor
AGM Batterij, 24V / 10A
+ externe conditiemeter
Artikel Nr M2134



Belly button ROOD
Artikel Nr M0121-BBUT



Schakelknop (2x) groen
Artikel Nr M0121-KNOP-GROEN



Schakelaar disselkop
excl. knoppen
Artikel Nr M0121-FLIPPER



Veer/as gaspedaal
Artikel Nr M0121-4

Meest voorkomende onderdelen



Schakelaar FAST/SLOW
disselkop groen
Artikel Nr M0121-SPEED-GROEN



Schakelaar ON/OFF
disselkop groen
Artikel Nr M0121-AANUIT-GROEN



Torsieveer voor haak
Artikel Nr M0116



Vulbus voor veer
Artikel Nr M0116-1



Italsea rijregelaar
in 24V / 36 bat,
in 30A / I_{max} 120A
Artikel Nr M2128



Koolborstels (set van 4)
voor motor 600W
Artikel Nr M1037

Meest voorkomende onderdelen



Accuconditiometer
voor inbouwlader 3-leds
Artikel Nr M0318



Kabelboom 2
Artikel Nr M1132



Zekering 5A
Artikel Nr M0506



Zekering Maxi 80A
Artikel Nr M0191



Chassisdeel kabel
inbouwlader
Artikel Nr M0158-Stekker



Aandrijf wiel, massief rubber
zwart Ø 250 x 80mm
Artikel Nr M0248

Meest voorkomende onderdelen



Aandrijf wiel, massief rubber
Nonmarking
Gray Ø 250 x 80mm
Item number M0115



Stuur wiel, massief rubber
zwart Ø 250 x 80 mm
Artikel Nr M6019



Stuur wiel, massief rubber,
non-marking
Grijs Ø 250 x 80 mm
Artikel Nr M0696

toepassingen



moveXX
driven by brain power

 **ASP**
Handling

ASP bvba
Baanakkerweg 3
B-3060 Bertem

+32 (0)16 36 12 24
info@asp-online.be
www.asp-online.be